

# T.5

hex 22

stainless steel

CAN bus technology

## Digital Pressure Transmitter with CANopen / CAN J1939 Interface

Hex 22



- Type 0630: CANopen protocol according to CiA DS-301, Device profile according to CiA DS-404
- Type 0631: CAN J1939 protocol according to SAE J1939
- Robust stainless steel construction with high reliability, even in very rough environments
- Completely welded measuring cell made of stainless steel 1.4542 ensures excellent media compatibility
- Measuring ranges from 0 - 1 bar to 0 - 600 bar (0 - 15 psi to 0 - 8,700 psi)

# Digital Pressure Transmitter with CANopen / CAN J1939 Interface

## Technical data



|                         |  |                                   |
|-------------------------|--|-----------------------------------|
| Type:                   | <b>0630</b>                            | <b>0631</b>                       |
| Output protocol:        | CANopen DIN EN 50325-4 <sup>1)2)</sup> | SAE J1939 <sup>1)</sup>           |
| Supply voltage $U_g$ :  | 10 V - 32 VDC                          | 10 V - 32 VDC                     |
| Idle power consumption: | < 30 mA                                | < 30 mA                           |
| CAN Interface:          | acc. to DIN ISO 11898-2 CAN 2.0 A      | acc. to DIN ISO 11898-2 CAN 2.0 B |

|                                      |  |                                   |                            |                            |                               |                               |                               |
|--------------------------------------|--|-----------------------------------|----------------------------|----------------------------|-------------------------------|-------------------------------|-------------------------------|
| Type:                                | <b>0630 / 0631</b>   |                                   |                            |                            |                               |                               |                               |
| Standard pressure ranges $p_{nom}$ : | 0 - 1 bar<br>(0 - 14.5 psi)  | 0 - 2,5 bar<br>(0 - 36 psi)       | 0 - 4 bar<br>(0 - 58 psi)  | 0 - 6 bar<br>(0 - 87 psi)  | 0 - 10 bar<br>(0 - 145 psi)   | 0 - 16 bar<br>(0 - 232 psi)   | 0 - 25 bar<br>(0 - 362 psi)   |
| Overpressure protection $p_u^{3)}$ : | 6 bar<br>(87 psi)  | 6 bar<br>(87 psi)                 | 10 bar<br>(145 psi)        | 20 bar<br>(290 psi)        | 20 bar<br>(290 psi)           | 40 bar<br>(580 psi)           | 100 bar<br>(1,450 psi)        |
| Burst pressure <sup>3)</sup> :       | 9 bar<br>(130 psi)   | 9 bar<br>(130 psi)                | 15 bar<br>(217 psi)        | 30 bar<br>(435 psi)        | 30 bar<br>(435 psi)           | 60 bar<br>(870 psi)           | 150 bar<br>(1,450 psi)        |
| Standard pressure ranges $p_{nom}$ : | 0 - 40 bar<br>(580 psi)  | 0 - 60 bar<br>(870 psi)           | 0 - 100 bar<br>(1,450 psi) | 0 - 160 bar<br>(2,320 psi) | 0 - 250 bar<br>(3,625 psi)    | 0 - 400 bar<br>(5,800 psi)    | 0 - 600 bar<br>(8,700 psi)    |
| Overpressure protection $p_u^{3)}$ : | 0 - 100 bar<br>(1,450 psi)   | 0 - 200 bar<br>(2,900 psi)        | 0 - 200 bar<br>(2,900 psi) | 0 - 400 bar<br>(5,800 psi) | 0 - 750 bar<br>(10,877 psi)   | 0 - 750 bar<br>(10,877 psi)   | 0 - 840 bar<br>(12,183 psi)   |
| Burst pressure <sup>3)</sup> :       | 0 - 150 bar<br>(2,175 psi)   | 0 - 300 bar<br>(4,350 psi)        | 0 - 300 bar<br>(4,350 psi) | 0 - 600 bar<br>(8,700 psi) | 0 - 1,000 bar<br>(14,500 psi) | 0 - 1,000 bar<br>(14,500 psi) | 0 - 1,050 bar<br>(15,229 psi) |
| Mechanical life expectancy:          | 10.000.000 pulsations at rise rates to 1 bar/ms at $p_{nom}$                         |                                   |                            |                            |                               |                               |                               |
| Permitted pressure change rate:      | $\leq 1$ bar/ms  |                                   |                            |                            |                               |                               |                               |
| Accuracy:                            | $\pm 0,5$ % of full scale (FS) at room temperature <sup>4)</sup> , $\pm 0,25$ % BFLS |                                   |                            |                            |                               |                               |                               |
| Long-term stability:                 | $< \pm 0,1$ % of full scale (FS) per year  |                                   |                            |                            |                               |                               |                               |
| Repeatability <sup>5)</sup> :        | $\pm 0,1$ % of full scale (FS)   |                                   |                            |                            |                               |                               |                               |
| Temperature error <sup>5)</sup> :    | 1,5 % of full scale (FS)   |                                   |                            |                            |                               |                               |                               |
| Compensated temperature range:       | -20 °F ... +185 °F   |                                   | (-20 °C ... +85 °C)        |                            |                               |                               |                               |
| Temperature range ambient:           | -40 °F ... +221 °F   |                                   | (-40 °C ... +105 °C)       |                            |                               |                               |                               |
| Temperature range media:             | -40 °F ... +257 °F   |                                   | (-40 °C ... +125 °C)       |                            |                               |                               |                               |
| Wetted parts material                | Housing:   | Stainless steel 1.4301 / AISI 304 |                            |                            |                               |                               |                               |
|                                      | Measuring cell:  | Stainless steel 1.4542            |                            |                            |                               |                               |                               |
| Insulation resistance:               | 100 M $\Omega$ (50 VDC, $R_i > 42 \Omega$ )  |                                   |                            |                            |                               |                               |                               |
| Response time 10 - 90 %:             | < 1 ms   |                                   |                            |                            |                               |                               |                               |
| Vibration resistance:                | 20 g acc. to IEC 68-2-6 and IEC 68-2-36  |                                   |                            |                            |                               |                               |                               |
| Shock resistance:                    | 1000 g acc. to IEC 68-2-32   |                                   |                            |                            |                               |                               |                               |
| Protection class:                    | IP67 (IP00 without mating plug)  |                                   |                            |                            |                               |                               |                               |
| Electromagnetic compatibility:       | EN 61326-2-3   |                                   |                            |                            |                               |                               |                               |
| Weight                               | 90 g   |                                   |                            |                            |                               |                               |                               |

<sup>1)</sup> Further information and the standard setting can be found in the Technical Documentation CANopen (1-6-30-628-058) as well as CAN J1939 (1-6-30-628-059) on our CANopen webpage.

<sup>2)</sup> The EDS (Electronic Data Sheet) of our CANopen device can be downloaded from our CANopen webpage.

<sup>3)</sup> Static pressure. Dynamic value is 30% to 50% lower. Values refer to the hydraulic/pneumatic part of the pressure transmitter.

<sup>4)</sup> Including non-linearity, hysteresis, repeatability, zero error and full scale (FS) according to IEC 61298-2.

<sup>5)</sup> Within the compensated temperature range.



# T.5

hex 22

stainless steel

CAN bus technology

## 0630 / 0631

Electrical connectors and threads



hex 22

| M12 DIN EN 61076 -2-101 A<br>CiA-DR303-1 |                    |
|--|--------------------|
|  |                    |
| Pin                                      | <b>0630 / 0631</b> |
| 1  | nc                 |
| 2  | Uv+                |
| 3  | Gnd                |
| 4  | CAN-High           |
| 5  | CAN-Low            |
| IP67                                     |                    |
| x ~ 60 mm                                |                    |
| d ~ Ø 22 mm                              |                    |
| <b>Order number: 032</b>                 |                    |

| G1/4 - DIN EN ISO 1179-2<br>(DIN 3852-E) |
|--|
|  |
| <b>Thread code: 41</b>                   |

| NPT 1/4                |
|------------------------|
|                        |
| <b>Thread code: 09</b> |



# 0630 / 0631

## Order matrix for digital pressure transmitters

|  |      |                |                     |               |                       |
|--|------|----------------|---------------------|---------------|-----------------------|
|  | Type | Pressure range | Pressure connection | Pressure unit | Electrical connection |
|--|------|----------------|---------------------|---------------|-----------------------|

|                      |             |   |   |   |   |
|----------------------|-------------|---|---|---|---|
|                      | ↓           | ↓ | ↓ | ↓ | ↓ |
| CANopen, CAN 2.0 A   | <b>0630</b> |   |   |   |   |
| CAN J1939, CAN 2.0 B | <b>0631</b> |   |   |   |   |

| Pressure range <sup>1)</sup>    | Max. overpressure <sup>2)</sup> |            |
|---------------------------------|---------------------------------|------------|
| 0 - 1.0 bar (approx. 14 PSI)    | 6 bar (87 psi)                  | <b>100</b> |
| 0 - 2.5 bar (approx. 36 PSI)    | 6 bar (87 psi)                  | <b>250</b> |
| 0 - 4.0 bar (approx. 58 PSI)    | 10 bar (145 psi)                | <b>400</b> |
| 0 - 6.0 bar (approx. 87 PSI)    | 20 bar (290 psi)                | <b>600</b> |
| 0 - 10 bar (approx. 145 PSI)    | 20 bar (290 psi)                | <b>101</b> |
| 0 - 16 bar (approx. 232 PSI)    | 20 bar (580 psi)                | <b>161</b> |
| 0 - 25 bar (approx. 362 PSI)    | 100 bar (1,450 psi)             | <b>251</b> |
| 0 - 40 bar (approx. 580 PSI)    | 100 bar (1,450 psi)             | <b>401</b> |
| 0 - 60 bar (approx. 870 PSI)    | 200 bar (2,900 psi)             | <b>601</b> |
| 0 - 100 bar (approx. 1.450 PSI) | 200 bar (2,900 psi)             | <b>102</b> |
| 0 - 160 bar (approx. 2.320 PSI) | 400 bar (5,800 psi)             | <b>162</b> |
| 0 - 250 bar (approx. 3.620 PSI) | 750 bar (10,877 psi)            | <b>252</b> |
| 0 - 400 bar (approx. 5.800 PSI) | 750 bar (10,877 psi)            | <b>402</b> |
| 0 - 600 bar (approx. 8.700 PSI) | 850 bar (12,328 psi)            | <b>602</b> |

### Pressure connection

|                                       |           |
|---------------------------------------|-----------|
| G 1/4 - DIN 3852, form E, male thread | <b>41</b> |
| NPT 1/4                               | <b>09</b> |

### Pressure unit

|     |          |
|-----|----------|
| bar | <b>B</b> |
| PSI | <b>P</b> |

### Electrical connection

|   |            |
|---|------------|
| M12x1 - DIN EN 61076-2-101 A, CiA-DR303-1 | <b>032</b> |
|---|------------|

|                           |             |            |           |          |            |
|---------------------------|-------------|------------|-----------|----------|------------|
|                           | ↓           | ↓          | ↓         | ↓        | ↓          |
| <b>Your order number:</b> | <b>063X</b> | <b>XXX</b> | <b>XX</b> | <b>X</b> | <b>032</b> |

# T.5

hex 22

stainless steel

CAN bus technology



**CAN J1939**

**CANopen**

**Suco**  
RoHSII  
compliant



<sup>1)</sup> The proprietary PGN and SPN of the respective pressure range can be found in the Technical Documentation CAN J1939 (1-6-30-628-059) on our homepage at: <https://www.suco.de/en/downloads>.

<sup>2)</sup> Static pressure. Dynamic value is 30 to 50% lower. Values refer to the hydraulic/pneumatic part of the pressure transmitter.

# Technical explanations for pressure transmitters

## What is a pressure transmitter?

A pressure transmitter (also called pressure transducer or pressure converter) is a component used to convert a pneumatic or hydraulic pressure to an electric (usually analogue and linear) output signal, such as a current or voltage.

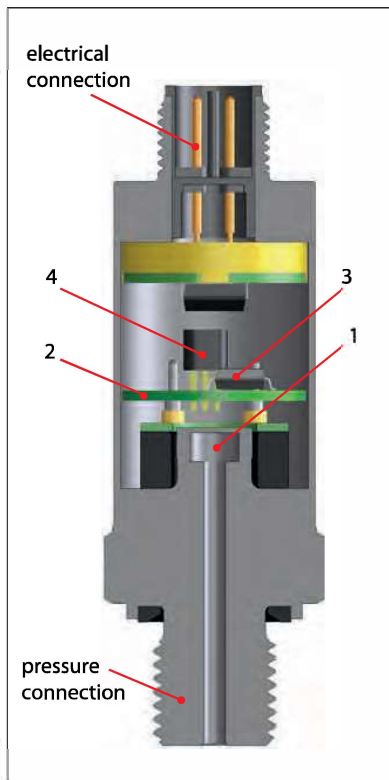

## How does a pressure transmitter work?

The pressure measuring cell fitted has a membrane (1) that is exposed to the pressure to be measured. Affixed on this membrane is a bridge circuit consisting of four ohmic resistors in the form of a Wheatstone bridge. The values of these resistors change proportionally to the pressure load present at the measuring cell or membrane. The bridge voltage of the measuring cell is amplified in the evaluation electronics (2) and processed digitally by a microcontroller (3).

The downstream output stage (4) converts this signal to the output signal required (such as 4 - 20 mA or 0 - 10 V).

## SoS technology

In the silicon-on-sapphire technology, the substrate of the thin film measuring cell is synthetic sapphire. This has excellent mechanical and temperature stable properties and prevents undesired parasitic effects, thereby having a positive effect on accuracy and stability. In conjunction with a titanium membrane, this results in virtually unique coaction between the temperature coefficients of sapphire and titanium.

This is because, unlike silicon and stainless steel, they are more closely matched and so only require a low level of compensation overhead. This also has a favourable effect on long-term stability.

## “Oil-filled” stainless steel measuring cell

In this measuring cell technology, the piezoresistive measuring cell is packaged within a metallic housing filled with fluorine oil. This means the measuring cell is virtually free of external mechanical stress. Fluorine oil has excellent characteristics in regards to temperature and ageing behaviour, and is not flammable and so fits perfectly to oxygen applications. It is not recommended for food applications.

## Ceramic measuring cell / thick film technology

Ceramic thick film pressure measuring cells are made up of a sintered ceramic body. The ceramic body sleeve already has the key geometries for the subsequent pressure range. The membrane thickness required and thus, the pressure range required is established with grinding and lapping. The resistors are imprinted with thick film technology and interconnect to form a measuring bridge.

## Standard signals

Output signals 4 - 20 mA, 0 - 10 V and 0.5 - 4.5 V ratiometric in particular have established themselves in the industry. SUCO also offers transmitters with customer-specific output signals (such as 1 - 5 V).

Block diagram:

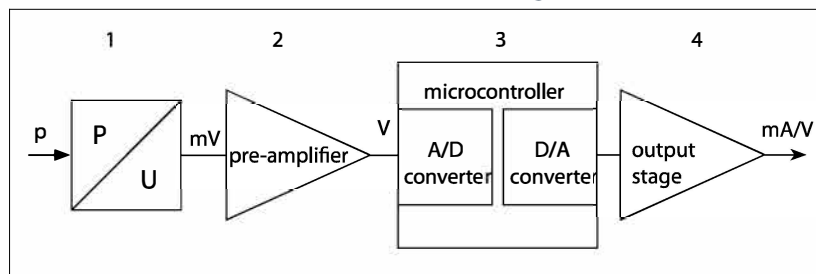

### Voltage output 0 - 10 V

Transmitters with an output signal of 0 to 10 V are a commonly used variant due to their simple initial operation and straightforward scaling of the signal (0 V for 0 bar). The output load must be selected as highly resistive (with typical minimum value 4.7 kΩ). SUCO transmitters with voltage output have a 3-wire design.

The maximum connection length should not exceed 30 m to prevent significant voltage drops in the signal line.

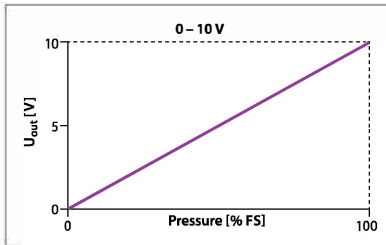

Conversion formula for pressure and voltage:

$$U_{\text{out}} = \frac{\text{pressure applied}}{\text{pressure range}} \times 10 \text{ V}$$

### Voltage output

#### 0.5 – 4.5 V ratiometric

SUCO transmitters with ratiometric output are operated with a 5 V supply voltage as 3-wire configuration. The output signal is directly proportional/dependent to/on the supply voltage; this is known as a ratiometric dependency. 0.5 – 4.5 V is established as an output voltage because many A/D converters work with reference voltage  $U_{V+}$  of 5 V. The output voltage 0.5 V equals to 10% and 4.5 V corresponds to 90% of the supply voltage. The span is therefore 80% of the supply voltage.

This variant is used for example when a transmitter and a downstream A/D converter as an evaluation unit are to be powered with the same reference / operating voltage.

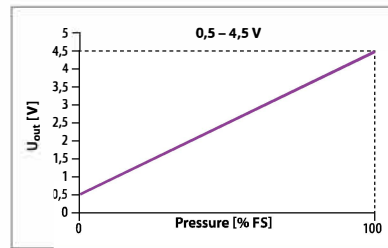

Conversion formula for pressure and voltage:

$$U_{\text{out}} = 0.1 \times U_{V+} + \frac{\text{pressure applied}}{\text{pressure range}} \times 0.8 \text{ V} \times U_{V+}$$

with  $U_{V+}$  = operating voltage

### Current output 4 – 20 mA

The most common analogue output signal of sensors is 4 – 20 mA current output (as 2-wire configuration). The advantage of a 4 – 20 mA output signal is the 4 mA offset which allows the monitoring of potential wire break and short-circuit (life zero signal).

The signal can also be transmitted over long distances with no loss in accuracy. This variant is also the least sensitive to EMC factors. 2-wire technology also means wiring overhead is reduced.

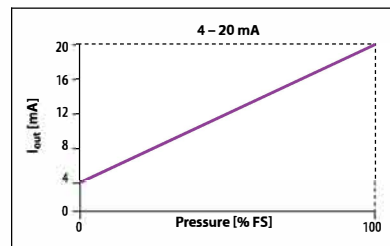

Conversion formula for pressure and voltage:

$$I_{\text{out}} = 4 \text{ mA} + \frac{\text{pressure applied}}{\text{pressure range}} \times 16 \text{ mA}$$

### Output for vacuum transmitters

As depicted in the sketch on the upper right the output is at maximum signal at zero pressure. Therefore at maximum vacuum the output signal is at its minimum.

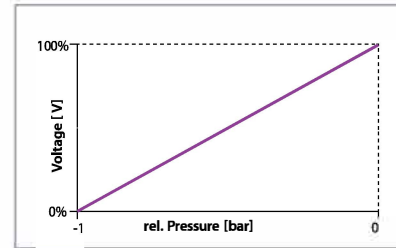

### Load / apparent ohmic resistance for pressure transmitters

An appropriate ohmic load must be connected to guarantee perfect functioning of a pressure transmitter.

For transmitters with a voltage output (V), the load should be at least 4.7 kΩ.

For transmitters with a current output (4 - 20 mA), the maximum load is calculated using the following formula:

$$R_L = \frac{U_{V+} - U_{V+(min)}}{20 \text{ mA}}$$

$U_{V+(min)}$  is the minimum supply voltage - to be taken from the data sheet.  $U_{V+(min)} = 10 \text{ V}$  gives the following operating range for example:

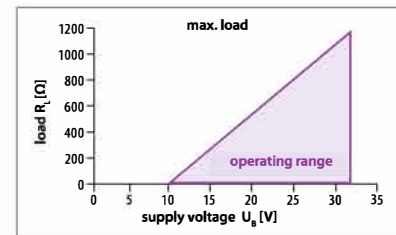

### Supply / operating voltage UB

All pressure transmitters work with DC voltage and have no galvanic isolation. Within the thresholds specified in the relevant data sheet, the supply voltage may change without influencing the output signal. (the ratiometric variant is an exception).

To guarantee the functionality of a transmitter, the minimum supply voltage may not fall below. The maximum operating voltage may not be exceeded to avoid damage on the electronics.

# Technical explanations for pressure transmitters

## Accuracy (to DIN EN 61298)

The (measuring) accuracy of pressure transmitters is specified by SUCO as  $\pm 0.5\%$  or  $\pm 1\%$  of the span (also called full scale). Accuracy includes zero point offset, non-linearity, hysteresis and non-repeatability, and is defined at room temperature and new state. This method defines the maximum deviation from the ideal line (in contrast to the BFSL method in which the average deviation is given). Other factors influencing the total accuracy, such as temperature and ageing, are specified separately.

## Non-linearity (to DIN EN 61298)

Non-linearity (also linearity) defines the deviation of the actual output curve from the theoretical ideal line. SUCO specifies the maximum error in relation to the overall span or full scale (FS) of the pressure range.

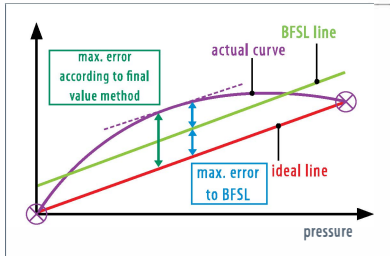

Non-linearity is also shown as BFSL (Best Fit Straight Line) as a reference value in the technical specifications. Non-linearity generally has the biggest influence on the overall error rate. Typically, non-linearity as per BFSL corresponds to half of non-linearity as per the full scale method (1% FS  $\sim$  0.5% BFSL).

## Hysteresis (to DIN EN 61298)

For a pressure transmitter, hysteresis specifies the difference of output signal between a rising and falling pressure, and is typically very low and negligible for SUCO pressure transmitters.

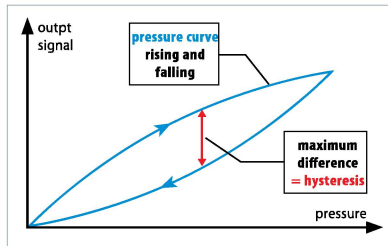

## Non-repeatability (to DIN EN 61298)

Non-repeatability defines reproducibility of the output signal. The pressure is attained three times for example - the maximum variance between these three values gives the non-repeatability.

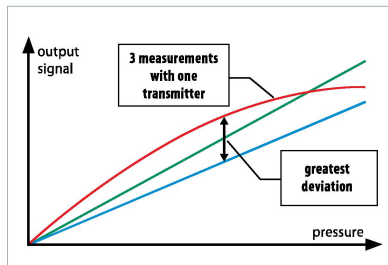

## Temperature errors and ranges

The temperature (both of the medium and ambience) generally has a significant influence on the accuracy of a pressure transmitter. Pressure transmitters are temperature compensated over a particular range corresponding to the typical application. This means that temperature errors within this temperature range are minimised by means of circuitry design and algorithms. The temperature error is added to the accuracy, and shown in the total error band of the pressure transmitter, also called butterfly graph. Outside the compensated temperature range, the maximum error is not defined, however the pressure transmitter still functions.

To prevent mechanical and electrical damage, pressure transmitters may not be deployed beyond the threshold temperature ranges specified in the data sheet.

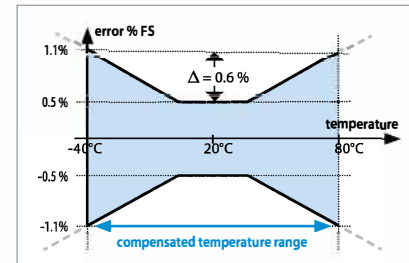

## Service life and long-term stability

Service life information pertains to nominal conditions specified in the data sheet, and can vary considerably when a product is operated mechanically or electrically outside the specifications. Service life essentially depends on the used measuring cell technology.

Ageing is accelerated (or slowed) due to different factors - such as temperature, temperature change and reduction of mechanical forces. The occurrence of ageing does effect the total accuracy.

SUCO specifies long-term stability in accordance with DIN 16086 in relation to one year. Typically the influence of aging on the accuracy reduces with increasing operating duration. The information in the data sheet corresponds to the worst case scenario.

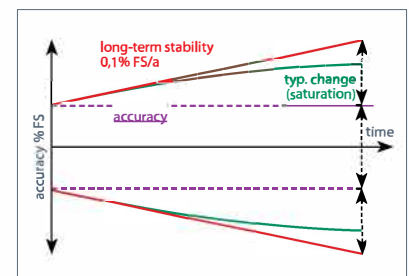

### Resolution

The A/D resolution (analogue - digital) of an pressure transmitter defines the smallest change of the analogue – digital – analogue conversion which takes place by the signal processing of an pressure transmitter.

If for example 13-bit resolution is used for an pressure transmitter with a 100 bar setting range, the smallest signal change is 8192 steps (213). As state of the art a resolution of 12 bits and hence 4096 steps (212) is typical. Therefore pressure changes of 100 bar / 4096 = 0.024 bar can be recorded.

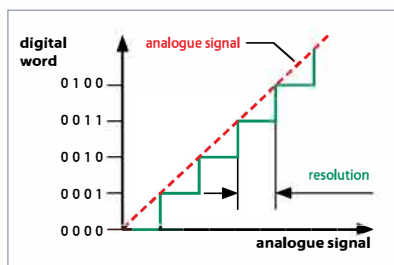

### Sampling rate

The sampling rate (or sampling frequency) defines the number of samples per time unit (typically in seconds or milliseconds) taken from an analogue signal and converted to a digital signal. The sampling rate is an indicator of how fast the output signal of a pressure transmitter responds to the pressure change at the input.

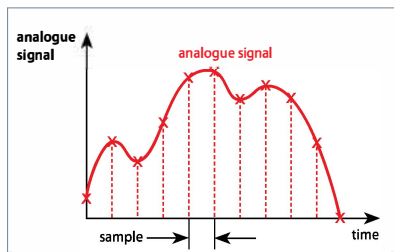

### Response time

The response or circuit time is shorter than 2 to 4 milliseconds (depending on model). The sum of A/D and D/A conversions, and the analogue and digital filters in the signal chain from the measuring bridge to the output, make up the response time. Filtering is used to suppress unwanted pressure peaks and electrical interference signals, and for good EMC characteristics.

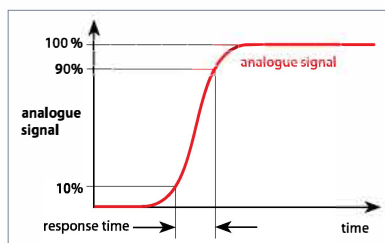

### CE mark

Pressure transmitters from SUCO fall under the 2014/30/EU EMC Directive.

EC declarations of conformity have been issued for the pressure transmitters are available on request or can be downloaded from our website. The relevant devices are denoted by a CE mark in our catalogue.

The Machinery Directive 2006/42 EC is not applicable, because our products are classed as components. Our products are designed for Group 2 fluids based upon good engineering practise in line with Pressure Equipment Directive 2014/68/EU, meaning neither a declaration of conformation may be issued nor a CE mark affixed.

### Electromagnetic compatibility (EMC)

Pressure transmitters from SUCO do comply to all important industrial EMC standards. The basis for the standards are the stricter thresholds for transient emissions in residential environments (EN 61000-6-3) and immunity for industrial environments (EN 61000-6-2).

| Generic standard  | Test standard                | Parameter(s)  |
|---|------------------------------|---|
| Radio disturbance and immunity  | EN 55016-2-1<br>EN 55016-2-3 | 60 dBuV   |
| Radiated, high-frequency electromagnetic field immunity test          | EN 61000-4-3                 | 10 V/m; 80-1000 MHz,<br>3 V/m; 1400-2000 MHz,<br>1 V/m; 2000-2700 MHz |
| Immunity to conducted disturbances, induced by radio-frequency fields | EN 61000-4-6                 | 10 V; 0,15-80 MHz   |
| Electrical fast transient / burst immunity test                       | EN 61000-4-4                 | ±2 kV   |
| Surge immunity test   | EN 61000-4-5                 | ±0,5 kV (common)<br>±0,5 kV (differential)                            |
| Electrostatic discharge (ESD) immunity test                           | EN 61000-4-2                 | air: 8 kV<br>with contact: 4 kV                                       |



# Technical explanations for pressure transmitters

## Conversion chart for pressure units

| Abbreviation for unit         | Name of unit                | Pa = N/m <sup>2</sup> | bar     | Torr    | lbf/in <sup>2</sup> , PSI |
|-------------------------------|-----------------------------|-----------------------|---------|---------|---------------------------|
| 1 Pa = N/m <sup>2</sup>       | Pascal                      | 1                     | 0.00001 | 0.0075  | 0.00014                   |
| 1 bar                         | Bar                         | 100 000               | 1       | 750.062 | 14.5                      |
| 1 Torr = 1 mmHg               | Millimeters of mercury      | 133.322               | 0.00133 | 1       | 0.01934                   |
| 1 lbf/in <sup>2</sup> = 1 PSI | Pound-force per square inch | 6894                  | 0.06894 | 51.71   | 1                         |

## Conversion chart for temperature units

|    | K                | °C           | F              |
|----|------------------|--------------|----------------|
| K  | 1                | K - 273.15   | 9/5 K - 459.67 |
| °C | °C + 273.15      | 1            | 9/5 °C + 32    |
| F  | 5/9 (F + 459.67) | 5/9 (F - 32) | 1              |

### Insulation strength

According to the latest specifications for immunity to surges and lightning protection, the following must be taken into account when testing insulation strength: With insulation test devices having an inner resistance exceeding 42 Ω, the insulation strength of pressure transmitters can be tested up to 500 VDC. All contacts must be tested short-circuited against the housing. For a specific threshold value of test voltage, the protective circuit for surge protection is activated without any defects arising within the circuit. In the process, the current may rise to a point at which an insulation strength fault is indicated. The recommendation therefore is to conduct the insulation test of the pressure transmitter when it is removed, or independently of the overall system.

### Medium compatibility

The specifications on medium compatibility in this catalogue pertain to the specific seal and housing materials as well as the used measuring cell technology and so cannot be generalised.

### Titanium

Its high levels of mechanical resistance and the wide media compatibility – in particular to corrosive media – do make titanium the ideal material for measuring cells and membranes. It is not recommended for oxygen or hydrogen applications.

### Stainless steel (1.4305 / AISI 303)

Stainless steel with broad level of media compatibility. Also suitable for oxygen and hydrogen applications.

### Stainless steel (1.4404 / AISI 316L)

Stainless steel with broad level of media compatibility. Also suitable for chemical industry and sea water applications.

### Oxygen and hydrogen

Country-specific safety requirements and application guidelines must be observed if the medium to be monitored is oxygen or hydrogen, such as DGUV accident prevention regulations (DGUV 500, Section 2.32 and BGI 617).

**Please specify when ordering “for oxygen, oil and grease-free”.**

### Pressure peak dampening

If required, our pressure transmitters can also be fitted with a pressure snubber (pressure peak orifice) to protect the measuring cell against transient pressure loads such as pressure peaks due to the switching of valves, cavitation effects, etc. which can shorten life expectancy.

For liquid media, the hole of a pressure snubber cannot be chosen to be any small size. At low temperatures the viscosity of the media will increase. In a case of dropping pressure the media might remain in the cavity behind the snubber which might affect the functionality of the pressure transmitter. Thus a bore diameter of 0.8 mm has been established.

### Product information

The technical information in this catalogue is based upon fundamental testing during product development, as well as upon empirical values. The information cannot be used for all application scenarios.

**Testing of the suitability of our products for a specific application (e.g. also the checking of material compatibilities) falls under the responsibility of the user. It may be the case that suitability can only be guaranteed with appropriate field testing.**

**Subject to technical changes.**